

## 1. Product Introduction, Features & Technical Parameters

### 1.1 Introduction:

VIS-3002 support EM or PIN to control single door, can drive electric lock, connect exit button, door magnetic detection and door bell button, also can be used as Reader working with controller. 500 pcs user capacity and each user owns one card and a 4-6 digits PIN.

### 1.2 Features:

- > Use RFID to open door, fashion, security and reliability.
- > Can be used as controller and reader, freely switch, easily operate.
- > Clear and beautiful luminous keypad, convenient for user to enter password & open door.
- > With door bell button, convenient for visitor.
- > 500 pcs user capacity, suit for office, villa and household use etc.
- > Wiring is very simple, can be done by users without professional knowledge; can be connected with various electric lock and no need to change external wiring.
- > Every user can change the password without master.
- > Password is 4-6 digits, more security.
- > Multiple output format of pressing key, can work with types of controller.
- > Anti-vandal, door magnetic detection alarm function.

### 1.3 Technical Parameters:

- > Input voltage: DC12~24V
- > Idle current:  $\leq 20\text{mA}$
- > Max reading distance: 5-8cm
- > Frequency: 125KHz
- > Door bell output load:  $\leq 10\text{mA}$
- > Lock output load:  $\leq 3\text{A}$
- > Output format of card No.: Wiegand26
- > Output format of pressing one key: 4bit, 8bit
- > Dimension: 130mm $\times$ 75mm $\times$ 17mm
- > Operating temperature: -40~60 $^{\circ}\text{C}$
- > Operating humidity: 0~95% (non-condensing)

## 2. Installation And Wiring Diagram

- Following the figure and draw the installation and cable hole on the wall. Use  $\phi 6\text{mm}$  drill bit for drilling two installation hole and  $\phi 10\text{mm}$  drill bit for drilling cable hole.
- Insert rubber bungs to installation hole, fix the back shell of controller on the wall.

· 01 ·

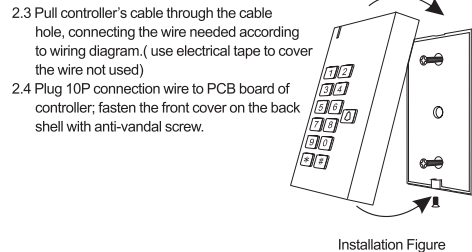

Installation Figure

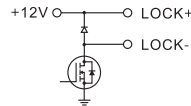

Principle of Electronic Lock

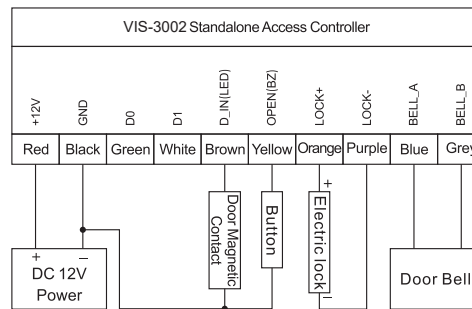

Wiring Diagram (DC Power Supply)

· 02 ·

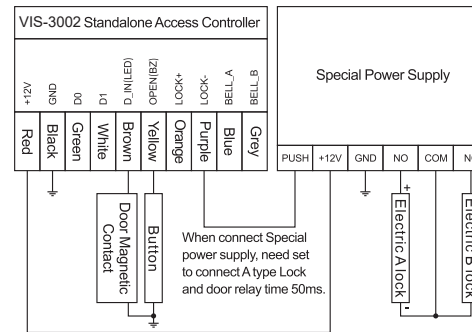

Wiring Diagram (Special Power Supply)

## 3. Master Setting

Note that all the following programming should be under master programming mode.

When master's PIN is wrong and the time is over 5s before you enter PIN again, it will return to standby mode. After enter right master's PIN, it will also return to standby mode if there is no valid operation in 30 seconds. Press "\*" to confirm the input number, return to previous menu by press "#", the indicator light will indicate the operation mode.

### To enter the master programming mode

Red	Red Flash	Functions	Remark
*	6-8 digits master's PIN #	To enter the programming mode	Factory default 888888

· 03 ·

## Access Controller Setting

Red Flash	Orange	Functions	Remark
0	6-8 digits new PIN # repeat 6-8 digits new PIN #	To change the master's PIN	
1	Read card 1-500(ID), #, Read card 8 or 10 digits card number ① # 1-500(ID), #, 8 or 10 digits card number # 1-500(ID), #, 4-6 digits PIN, #	To add card users ②	Rotate Operation ③
2	Read card 8 or 10 digits card number, # 1-500(ID), #	Delete one card Delete one user	Rotate Operation
2	0000, # (Note: This is a dangerous option, so use with care)	Delete All users	
3	0, # 1, # 2, #	Entry by Card only Entry by Card and PIN together Entry by either card or PIN	Factory default 2
4	0, # 1-99, #	To set door relay time 50mS To set door relay time 1-99S	Factory default 5s
5	0, # 1, #	Connect to A type of lock ④ Connect to B type of lock ⑤	Factory default 1

## Reader Setting

Red Flash	Orange Flash	Orange	Functions	Remark
7	1	0, # 1, #	Reader mode Access controller mode	Factory default 1
	3	0, # 1, # 2, #	Virtual card No. 4Bit of pressing one key 8Bit of pressing one key	Factory default 1

Note:

- 8 digits card No., for example 118, 32319, some cards have no the first 3 digits 118, remain 32319, in this case, add card user by reading card but not enter card number.
- 10 digits card No., for example 0007765567, some cards have no the first 3 digits 000, remain 7765567, in this case, you need enter 000 before 7765567 to add this card user.

· 04 ·

- A PIN 1234 will be generated automatically when we add a card user; it is only for changing new PIN, not to open door.
- After a card is added, you can continue to add other cards or PIN without exiting current setting mode and start over.
- A type of lock refers to those lock that normally under standby status, there is no current for lock, when there is current the door will open, such as electrified lock, electric strike.
- B type of lock refers to those lock that normally under standby status, there is current for lock, when there is no current the door will open, such as electromagnetic lock, electric drop bolt.

## 4. User Operation

4.1 Swiping Card to open door:

[Swiping user card once], door will be opened.

4.2 Swiping Card+PIN to open door:

[Swiping user card once, and enter 4-6digits PIN, #], door will be opened.

4.3 Card or PIN to open door:

[Swiping user card once or enter 4-6digits PIN, #], door will be opened.

4.4 Change the user's PIN

[\*], [Swipe user card], [Enter 4-6 digits old PIN, #], [Enter 4-6 digits new PIN, #],

[Repeat Enter 4-6 digits new PIN, # Or \*], [Enter 1-500(ID No.), #],

[Enter 4-6 digits old PIN, #], [Enter 4-6 digits new PIN, #],

[Repeat Enter 4-6 digits new PIN, #]

Remarks: PIN users have to get the ID No. and initial PIN from master. Card users have to swipe card when change the PIN first time.

4.5 Door bell:

Press door bell button on VIS-3002, the connected external door bell will ring.

Note: External door bell should be low current ( $\leq 10\text{mA}$ ).

## 5. Alarm Function

5.1 Anti-vandal alarm

If anti-vandal alarm function is on and when device is opened illegally, controller will sound alarm.

5.2 Door Magnetic detection alarm

If the door is connected with magnetic contact, and is opened illegally or by force, controller will sound alarm.

5.3 Remove the alarm

Swipe valid card or enter master's PIN can remove alarm. If there is no any operation the alarm will stop automatically after 1 minute.

· 05 ·

## 6. Reset To Factory Default

Power off, press "\*" and power on, the LED turns into ORANGE in 1s, and then release the button "\*" after you hear "Beep Beep", And then you hear "Bee-eeep", the LED turns into Red means reset to Factory Default successfully. But it won't delete all user information.

## 7. Sound And Light Indication

Operation Status	Color of LED	Buzzer
Stand by	Red	
Pressing keypad		Beep
Swipe card	Green	Bee-eeep
Unlocking	Green	Bee-eeep
Successful	Green	Bee-eeep
Fail		Beep Beep Beep
Entering PIN	RED flash slow	
Swiping card under way of swiping card+PIN	RED flash slow	
First menu of setting	RED flash slow	
Second menu of setting	Orange flash slow	
Setting	Orange	
Alarming	Red flash quick	Alarm sound

## 8. Card Reader Mode (Wiring Diagram As Below)

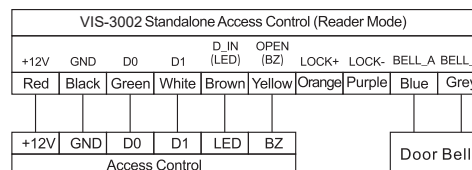

To use the card reader function, first set the machine for card reader mode, it has following functions:  
When LED level is low, LED light will turn into Green, after 30 seconds or LED level rising, LED light will return to normal.  
When BZ level is low, the Buzzer will beep, after 30 seconds or BZ level rising, the Buzzer will return to normal.

· 06 ·

Both card number and pressing keypad output in Wiegand format, output data is transmitted by the Low Level of D0 & D1 wire:

D0: Low level means 0, green wire

D1: Low level means 1, white wire

The Pulse width for low level is 40uS; and the time interval is 2mS.

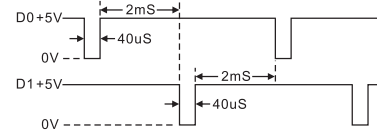

Output format of card number is Wiegand 26.

Output format of pressing keypad can be set 3 formats:

Format 0: virtual card No., namely enter 4-6 digits PIN, #, output a 10bits card number in Wiegand 26 format. For example, enter a password 999999, the output card number is 0000999999, could be displayed as a 10bits decimal card number on a equipment which support to display it.

Format 1: 4 bit of pressing one key, which is pressing every single key, output a 4bit data, the corresponding relationship is:

1 (0001), 2 (0010), 3 (0011)

4 (0100), 5 (0101), 6 (0110)

7 (0111), 8 (1000), 9 (1001)

\* (1010), 0 (0000), # (1011)

Format 2: 8 bit of pressing one key, which is pressing every single key, output a 8bit data, the corresponding relationship is:

1 (11100001), 2 (11010010), 3 (11000011)

4 (10110100), 5 (10100101), 6 (10010110)

7 (10000111), 8 (01111000), 9 (01101001)

\* (01011010), 0 (11110000), # (01001011)

## 9. Packing List

Name	Model No	Qty.	Remark
Access controller	VIS-3002	1	
10P connection wire		1	
User manual	VIS-3002	1	
Rubber Bung		2	Used for fixing installation
Self Tapping Screw	$\phi 4\text{mm} \times 25\text{mm}$	2	Used for fixing installation
Special Screwdriver		1	Special tool of security screw

· 07 ·

VISIONIS

VIS-3002

Standalone Access Controller/Reader

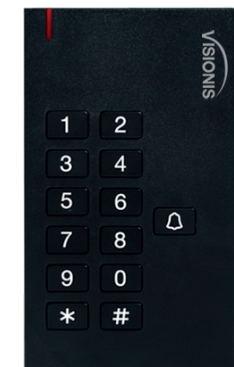

User Manual