



VZ-TVI-D2040VF HD1080P Vari-focal IR Turret Camera User Manual

Regulatory Information

FCC Information

FCC compliance: This equipment has been tested and found to comply with the limits for a digital device, pursuant to part 15 of the FCC Rules. These limits are designed to provide reasonable protection against harmful interference when the equipment is operated in a commercial environment. This equipment generates, uses, and can radiate radio frequency energy and, if not installed and used in accordance with the instruction manual, may cause harmful interference to radio communications. Operation of this equipment in a residential area is likely to cause harmful interference in which case the user will be required to correct the interference at his own expense.

FCC Conditions

This device complies with part 15 of the FCC Rules. Operation is subject to the following two conditions:

1. This device may not cause harmful interference.
2. This device must accept any interference received, including interference that may cause undesired operation.

EU Conformity Statement



This product and - if applicable - the supplied accessories too are marked with "CE" and comply therefore with the applicable harmonized European standards listed under the Low Voltage Directive 2006/95/EC, the EMC Directive 2004/108/EC, the RoHS Directive 2011/65/EU.



2012/19/EU (WEEE directive): Products marked with this symbol cannot be disposed of as unsorted



municipal waste in the European Union. For proper recycling, return this product to your local supplier

upon the purchase of equivalent new equipment, or dispose of it at designated collection points. For more information see: www.recyclethis.info.



2006/66/EC (battery directive): This product contains a battery that cannot be disposed of as unsorted municipal waste in the European Union.

See the product documentation for specific battery information. The battery is marked with this symbol, which may include lettering to indicate cadmium (Cd), lead (Pb), or mercury (Hg).

For proper recycling, return the battery to your supplier or to a designated collection point. For more information see: www.recyclethis.info.

www.vezcocctv.com

Thank you for purchasing our product. If there are any questions, or requests, please do not hesitate to contact the dealer.

This manual may contain several technical incorrect places or printing errors, and the content is subject to change without notice. The updates will be added to the new version of this manual. We will readily improve or update the products or procedures described in the manual.

Privacy Notice

Surveillance laws vary by jurisdiction. Check all relevant laws in your jurisdiction before using this product for surveillance purposes to ensure that your use of this product conforms.

Please refer to the product specification for camera parameters and functions.

1 Introduction

1.1 Product Features

This series of camera adopts new generation sensor with high sensitivity and advanced circuit design technology. It features high resolution, low image distortion and low noise, etc., which makes it suitable for surveillance system and image processing system.

- High performance CMOS sensor and high resolution bring high-quality image;
- Low illumination;
- OSD menu, parameters are configurable;
- Support auto white balance, auto gain control, electronic shutter control;
- Support image effect adjustment;
- Unit transmission control;
- Advanced 3-axis design meets different installation requirements.



Cameras in some models do not support OSD menu. For actual operation, please refer to the specification of each model.

1.2 Overview

1.2.1 Overview of Type I Camera

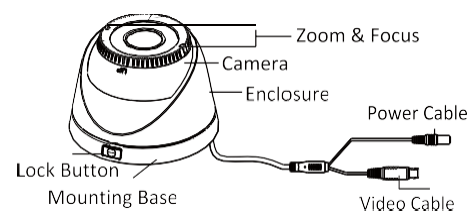

Figure 1-1 Overview of Type I Camera

1.2.2 Overview of Type II Camera

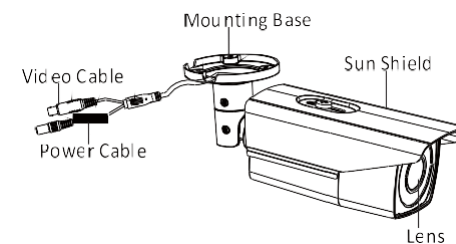

Figure 1-2 Overview of Type II Camera

2 Installation

Before you start:

- Please make sure that the device in the package is in good condition and all the assembly parts are included.
- Make sure that all the related equipment is power-off during the installation.
- Check the specification of the products for the installation environment.
- Check whether the power supply is matched with your power output to avoid damage.
- Please make sure the wall is strong enough to withstand three times the weight of the camera and the mounting.
- If the wall is the cement wall, you need to insert expansion screws before you install the camera. If the wall is the wooden wall, you can use self-tapping screw to secure the camera.
- If the product does not function properly, please contact your dealer or the nearest service center. Do not disassemble the camera for repair or maintenance by yourself.

2.1 Installation of Type I Camera

Steps:

1. Drill the screw holes and the cable hole on the ceiling according to the supplied drill template.

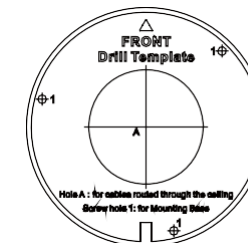

Figure 2-1 the Drill Template

2. Push the lock button to disassemble the camera from the mounting base.

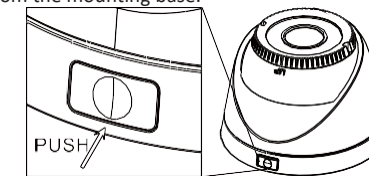

Figure 2-2 Release the Lock Screw

3. Fix the mounting base to the ceiling.
4. Route the cables to the cable hole and connect the corresponding cables.
5. Secure the camera to the mounting base by supplied screws. Keep the word UP on the camera being upright during the installation to make the image showing normally.

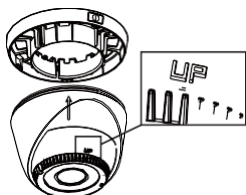

Figure 2-3 Secure the Camera

6. Adjust the camera according to the figure below to get an optimum angle.

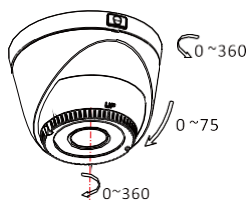

Figure 2-4 Universal Adjustment

7. Use the screwdriver to adjust the ZOOM screw and the FOCUS screw until you get the optimum image.

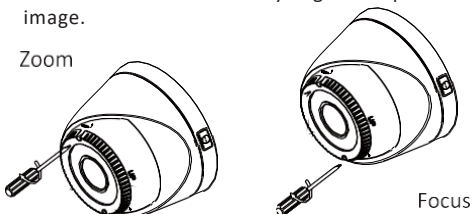

Figure 2-5 Zoom and Focus Adjustment

2.2 Installation of Type II Camera

Both wall mounting and ceiling mounting are suitable for type II bullet camera. Ceiling mounting will be taken as an example in the section. And you can take steps of ceiling mounting as a reference if wall mounting is adopted.

Steps:

1. Drill the screw holes and the cable hole in the ceiling according to the supplied drill template.
2. Hammer the supplied plastic expansion bolt into the screw holes.

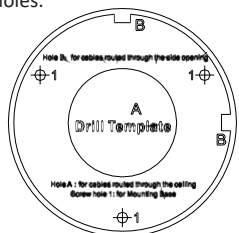

Figure 2-6 Drill Template

3. Route the cables to the cable hole and connect the corresponding cables.
4. Fix the camera to the ceiling with the supplied screws.

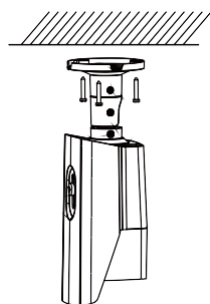

Figure 2-7 Fix the Camera to the Ceiling

5. Adjust the surveillance angle.
 - 1). Loosen No.1 adjusting screw to adjust the pan position (0° ~ 360°).
 - 2). Tighten No.1 adjusting screw.
 - 3). Loosen No.2 adjusting screw to adjust the tilting position (0° ~ 90°).
 - 4). Tighten No.2 adjusting screw.
 - 5). Loosen No.3 adjusting screw to adjust the rotation position (0° ~ 360°).
 - 6). Tighten No.3 adjusting screw.

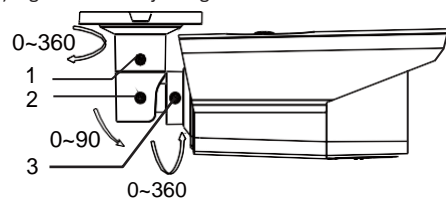

Figure 2-8 3-axis Adjustment

6. Push the focus & zoom adjustment cover upward to move it aside.
7. Use the cover as a screwdriver to adjust the ZOOM screw and the FOCUS screw until you get the optimum image.

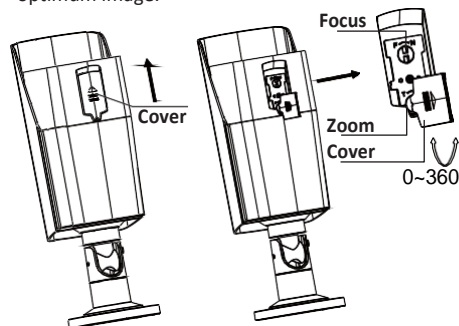

Figure 2-9 Zoom and Focus Adjustment

3 Menu Operation

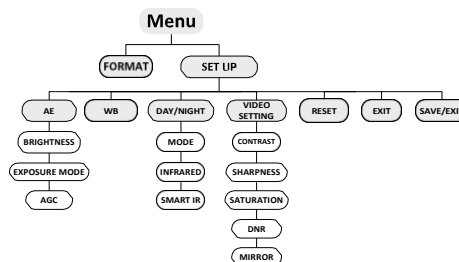

Figure 3-1 Main Menu



With a coaxial camera controller (purchase separately) or calling the preset No.95 you can select the menu and adjust the camera parameters.

3.1 FORMAT

You can set the format as PAL/NTSC.

3.2 SET UP

Move the cursor to **SET UP**, and press menu button to enter the SET UP sub menu.

3.2.1 AE

Move the cursor to AE, and you can adjust the image brightness by the **BRIGHTNESS**, **EXPOSURE MODE**, and **AGC**.

Brightness: Brightness refers to the brightness of the image.

Exposure Mode:

Move the cursor to **Exposure Mode**, you can select the exposure mode between **Globe** and **BLC**. When BLC is selected as the exposure mode, the level of BLC mode can be adjusted, as shown in the Figure 3-2.

| EXPOSURE | |
|------------------|----------|
| 1. BRIGHTNESS | ← 5 ▶ |
| 2. EXPOSURE MODE | ← BLC ▶ |
| LEVEL | ← 5 ▶ |
| 3. AGC | MIDDLE ▶ |
| 4. RETURN | ← |

Figure 3-2 EXPOSURE

| WB | |
|--------|--------|
| MODE | MWB |
| R GAIN | 1- -10 |
| B GAIN | 1- -10 |
| RETURN | |

Figure 3-3 WB

AGC:

AGC optimizes the clarity of image in poor light scene. AGC level can be set as OFF, LOW, MIDDLE and HIGH.

3.2.2 WB

Move the cursor to WB, and you can set White Balance mode as **AWB** and **MWB** in this menu.

AWB: white balance is being adjusted automatically.

MWB: Set the **R GAIN/B GAIN** value from 1 to 10. As shown in Figure 3-3.

3.2.3 DAY & NIGHT

Move the cursor to DAY & NIGHT, and select **COLOR**, **B/W**, or **SMART** as the DAY & NIGHT mode.

COLOR: The image is colored in day mode all the time.

B/W: The image is black & white all the time, and the IR LED turns on in the low-light conditions.

SMART: Select to turn on/off the INFRARED_LAMP and to set the Smart IR level from 1 to 16. As shown in Figure 3-4.

| DAY/NIGHT | |
|-----------|-------|
| MODE | SMART |
| INFRARED | OFF |
| SMART IR | 0- -5 |
| RETURN | ← |

Figure 3-4 DAY/NIGHT

3.2.4 VIDEO SETTING

Contrast:

Contrast enhances the difference in color and light between parts of an image.

You can set the value from 1 to 10.

Sharpness:

Sharpness determines the amount of detail that an imaging system can reproduce. You can set the value from 1 to 10.

Saturation:

You can set the saturation level of the image. The value is from 0 to 10.

DNR:

DNR decreases the noise effect, especially in low light conditions and delivers more accurate and sharp image quality. You can set the value from 0 to 7.

Mirror:

You can set the Mirror status as H, V, HV, or OFF.

3.2.5 Reset

Reset all the settings to the default.

3.2.6 EXIT

Exit and Save & exit are selectable.

3.2.7 SAVE/EXIT

Move the cursor to **SAVE & Exit**, and press OK to save the settings and exit the menu.