



# **NETWORK VIDEO RECORDER**

## **Quick Start Guide**

[www.vezcocctv.com](http://www.vezcocctv.com)

## **Quick Start**

### **Guide About this**

#### **Manual**

This Manual is applicable to Network Video Recorder (NVR).

The Manual includes instructions for using and managing the product. Pictures, charts, images and all other information hereinafter are for description and explanation only. The information contained in the Manual is subject to change, without notice, due to firmware updates or other reasons. Please find the latest version in the company website [www.vezcocctv.com](http://www.vezcocctv.com).

Please use this user manual under the guidance of professionals.

#### **Legal Disclaimer**

TO THE MAXIMUM EXTENT PERMITTED BY APPLICABLE LAW, THE PRODUCT DESCRIBED, WITH ITS HARDWARE, SOFTWARE AND FIRMWARE, IS PROVIDED "AS IS", WITH ALL FAULTS AND ERRORS, AND OUR COMPANY MAKES NO WARRANTIES, EXPRESS OR IMPLIED, INCLUDING WITHOUT LIMITATION, MERCHANTABILITY, SATISFACTORY QUALITY, FITNESS FOR A PARTICULAR PURPOSE, AND NON-INFRINGEMENT OF THIRD PARTY. IN NO EVENT WILL OUR COMPANY, ITS DIRECTORS, OFFICERS, EMPLOYEES, OR AGENTS BE LIABLE TO YOU FOR ANY SPECIAL, CONSEQUENTIAL, INCIDENTAL, OR INDIRECT DAMAGES, INCLUDING, AMONG OTHERS, DAMAGES FOR LOSS OF BUSINESS PROFITS, BUSINESS INTERRUPTION, OR LOSS OF DATA OR DOCUMENTATION, IN CONNECTION WITH THE USE OF THIS PRODUCT, EVEN IF OUR COMPANY HAS BEEN ADVISED OF THE POSSIBILITY OF SUCH DAMAGES.

REGARDING TO THE PRODUCT WITH INTERNET ACCESS, THE USE OF PRODUCT SHALL BE WHOLLY AT YOUR OWN RISKS. OUR COMPANY SHALL NOT TAKE ANY RESPONSIBILITIES FOR ABNORMAL OPERATION, PRIVACY LEAKAGE OR OTHER DAMAGES RESULTING FROM CYBER ATTACK, HACKER ATTACK, VIRUS INSPECTION, OR OTHER INTERNET SECURITY RISKS; HOWEVER, OUR COMPANY WILL PROVIDE TIMELY TECHNICAL SUPPORT IF REQUIRED.

SURVEILLANCE LAWS VARY BY JURISDICTION. PLEASE CHECK ALL RELEVANT LAWS IN YOUR JURISDICTION BEFORE USING THIS PRODUCT IN ORDER TO ENSURE THAT YOUR USE CONFORMS THE APPLICABLE LAW. OUR COMPANY SHALL NOT BE LIABLE IN THE EVENT THAT THIS PRODUCT IS USED WITH ILLEGITIMATE PURPOSES.

IN THE EVENT OF ANY CONFLICTS BETWEEN THIS MANUAL AND THE APPLICABLE LAW, THE LATER PREVAILS

## Regulatory Information

### FCC Information

Please take attention that changes or modification not expressly approved by the party responsible for compliance could void the user's authority to operate the equipment.

**FCC compliance:** This equipment has been tested and found to comply with the limits for a Class A digital device, pursuant to part 15 of the FCC Rules. These limits are designed to provide reasonable protection against harmful interference when the equipment is operated in a commercial environment. This equipment generates, uses, and can radiate radio frequency energy and, if not installed and used in accordance with the instruction manual, may cause harmful interference to radio communications. Operation of this equipment in a residential area is likely to cause harmful interference in which case the user will be required to correct the interference at his own expense.

### FCC Conditions

This device complies with part 15 of the FCC Rules. Operation is subject to the following two conditions:

1. This device may not cause harmful interference.
2. This device must accept any interference received, including interference that may cause undesired operation.

### EU Conformity Statement



This product and - if applicable - the supplied accessories too are marked with "CE" and comply therefore with the applicable harmonized European standards listed under the EMC Directive

2014/30/EU, the LVD Directive 2014/35/EU, the RoHS Directive 2011/65/EU.



2012/19/EU (WEEE directive): Products marked with this symbol cannot be disposed of as unsorted municipal waste in the European Union. For proper recycling, return this product to your local supplier upon the purchase of equivalent new equipment, or dispose of it at designated collection points. For more information see: [www.recyclethis.info](http://www.recyclethis.info)



2006/66/EC (battery directive): This product contains a battery that cannot be disposed of as unsorted municipal waste in the European Union. See the product documentation for specific battery information. The battery is marked with this symbol, which may include lettering to indicate cadmium (Cd), lead (Pb), or mercury (Hg). For proper recycling, return the battery to your supplier or to a designated collection point. For more information see: [www.recyclethis.info](http://www.recyclethis.info)

### Industry Canada ICES-003 Compliance



This device meets the CAN ICES-3 (A)/NMB-3(A) standards requirements.

# Safety Instruction

These instructions are intended to ensure that user can use the product correctly to avoid danger or property loss. The precaution measure is divided into “Warnings” and “Cautions”

**Warnings:** Serious injury or death may occur if any of the warnings are neglected.

**Cautions:** Injury or equipment damage may occur if any of the cautions are neglected.

	
<b>Warnings</b> Follow these safeguards to prevent serious injury or death.	<b>Cautions</b> Follow these precautions to prevent potential injury or material damage.



## Warnings

- Proper configuration of all passwords and other security settings is the responsibility of the installer and/or end-user.
- In the use of the product, you must be in strict compliance with the electrical safety regulations of the nation and region. Please refer to technical specifications for detailed information.
- Input voltage should meet both the SELV (Safety Extra Low Voltage) and the Limited Power Source with 100~240 VAC or 12 VDC according to the IEC60950-1 standard. Please refer to technical specifications for detailed information.
- Do not connect several devices to one power adapter as adapter overload may cause overheating or a fire hazard.
- Please make sure that the plug is firmly connected to the power socket.
- If smoke, odor or noise rise from the device, turn off the power at once and unplug the power cable, and then please contact the service center.

# Preventive and Cautionary Tips

Before connecting and operating your device, please be advised of the following tips:

- Ensure unit is installed in a well-ventilated, dust-free environment.
- Unit is designed for indoor use only.
- Keep all liquids away from the device.
- Ensure environmental conditions meet factory specifications.
- Ensure unit is properly secured to a rack or shelf. Major shocks or jolts to the unit as a result of dropping it may cause damage to the sensitive electronics within the unit.
- Use the device in conjunction with an UPS if possible.
- Power down the unit before connecting and disconnecting accessories and peripherals.
- A factory recommended HDD should be used for this device.
- Improper use or replacement of the battery may result in hazard of explosion. Replace with the same or equivalent type only. Dispose of used batteries according to the instructions provided by the battery manufacturer.



## Applicable Models

This manual is applicable to the models listed in the following table.

Model
VZ-NVR3200-4HD
VZ-NVR3200-4HD-P
VZ-NVR-3200-16P
VZ-NVR-81080-P
VZ-NVR-161080-P

## Symbol Conventions

The symbols that may be found in this document are defined as follows.

Symbol	Description
	Indicates a potentially hazardous situation, which if not avoided, could result in equipment damage, data loss, performance degradation, or unexpected results.
	Provides additional information to emphasize or supplement important points of the main text.

# TABLE OF CONTENTS

<b>Chapter1 Panels Description .....</b>	<b>7</b>
1.1 Front Panel.....	7
1.1.1 VZ-NVR3200-4HD, VZ-NVR3200-4HD-P, VZ-NVR-3200-16P .....	7
1.1.2 VZ-NVR-81080-P, VZ-NVR-161080-P .....	8
1.2 Rear Panel .....	8
1.2.1 VZ-NVR3200-4HD-P, VZ-NVR-3200-16P .....	8
1.2.2 VZ-NVR-81080-P .....	9
<b>Chapter 2 Installation and Connections.....</b>	<b>11</b>
2.1 NVR Installation.....	11
2.2 Hard Disk Installation .....	11
2.3 Connections .....	13
2.3.1 Alarm Input Wiring .....	13
2.3.2 Alarm Output Wiring.....	13
2.3.3 Using Alarm Connectors .....	13
2.3.4 Controller Connection .....	14
2.4 HDD Storage Calculation Chart.....	15
<b>Chapter 3 Menu Operation .....</b>	<b>16</b>
3.1 Menu Structure.....	16
3.2 Startup and Shutdown .....	16
3.3 Activating Your Device .....	17
3.4 Using the Unlock Pattern for Login .....	18
3.5 Login and Logout.....	19
3.5.1 User Login .....	19
3.5.2 User Logout .....	19
3.6 Using the Setup Wizard.....	20
3.7 Network Settings .....	20
3.8 Adding IP Cameras .....	21
3.9 Live View .....	22
3.10 Recording Settings .....	23
3.11 Playback.....	23
<b>Chapter 4 Accessing by Web Browser .....</b>	<b>25</b>

# Chapter 1 Panels Description

## 1.1 Front Panel

### 1.1.1 VZ-NVR3200-4HD-P, VZ-NVR-3200-16P

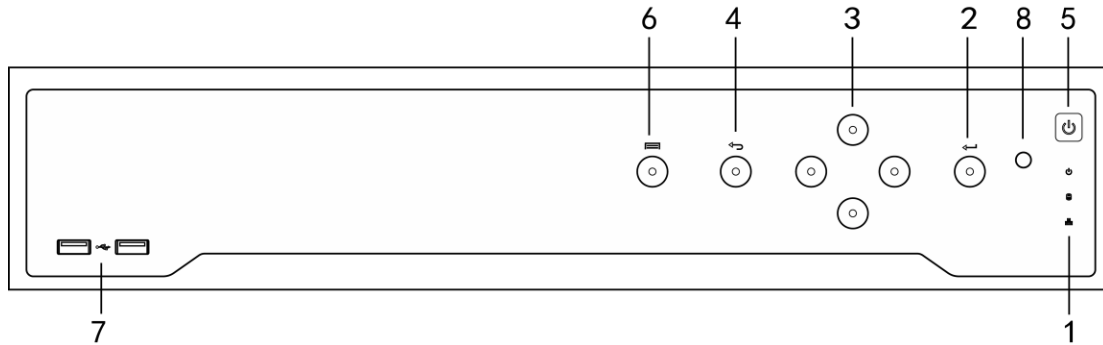

Figure 1. 3 VZ-NVR3200-4HD-P, VZ-NVR-3200-16P

Table 1. 2 Panel Description

No.	Name	Function Description	
1	Status Indicators	<b>POWER</b>	Turns green when NVR is powered up.
		<b>HDD</b>	Blinks red when HDD is reading/writing.
		<b>Tx/Rx</b>	Blinks green when network connection is functioning normally.
2	<b>ENTER</b>	The Enter button is used to confirm selection in menu mode; or used to check checkbox fields and ON/OFF switch.	
		In playback mode, it can be used to play or pause the video.	
		In single-frame play mode, pressing the Enter button will play the video by a single frame.	
		In auto sequence view mode, the buttons can be used to pause or resume auto sequence.	
3	<b>DIRECTION</b>	The Enter button is used to confirm selection in menu mode; or used to check checkbox fields and ON/OFF switch.	
		In menu mode, the direction buttons are used to navigate between different fields and items and select setting	
		In playback mode, the Up and Down buttons are used to speed up and slow down record playing, and the Left and Right buttons are used to move the recording 30s forwards	
		In the image setting interface, the up and down button can adjust the level bar of the image parameters. In live view mode, these buttons can be used to switch	
4	<b>Back</b>	Back to the previous menu.	
5	<b>POWER ON/OFF</b>	Power on/off switch.	

6	<b>MENU</b>	Access the main menu interface.
7	<b>USB Interface</b>	Universal Serial Bus (USB) ports for additional devices such as USB mouse and USB Hard Disk Drive (HDD).

### 1.1.2 VZ-NVR-81080-P, VZ-NVR-161080-P

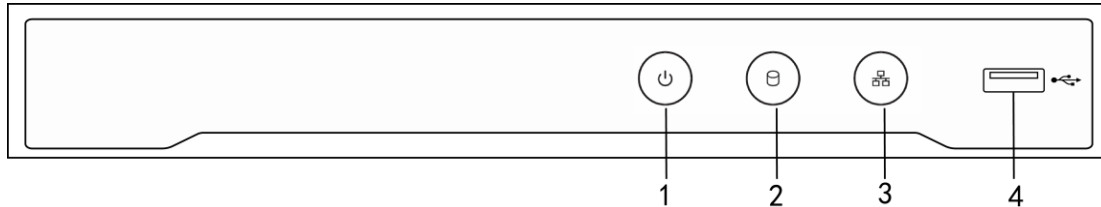

Figure 1. 5 VZ-NVR-81080-P, VZ-NVR-161080-P

Table 1. 3 Panel Description

No.	Name	Connections
1	<b>POWER</b>	Turns green when NVR is powered up.
2	<b>HDD</b>	Flickers red when data is being read from or written to HDD.
3	<b>Tx/Rx</b>	Flickers blue when network connection is functioning properly.
4	<b>USB Interface</b>	Universal Serial Bus (USB) port for additional devices such as USB mouse and USB Hard Disk Drive (HDD).

## 1.2 Rear Panel

### 1.2.1 VZ-NVR3200-4HD-P, VZ-NVR-3200-16P

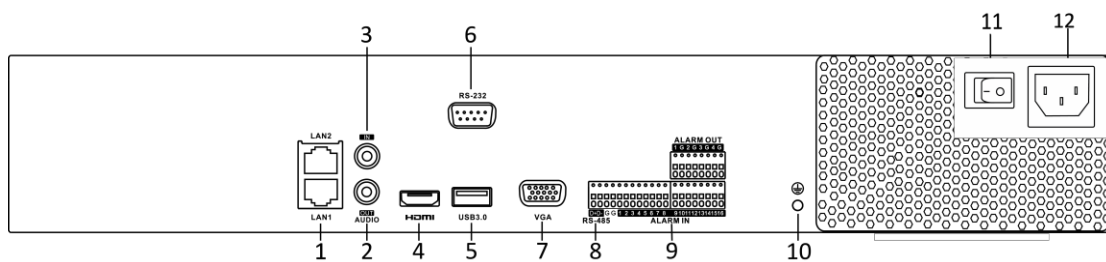

Figure 1. 8 VZ-NVR3200-4HD

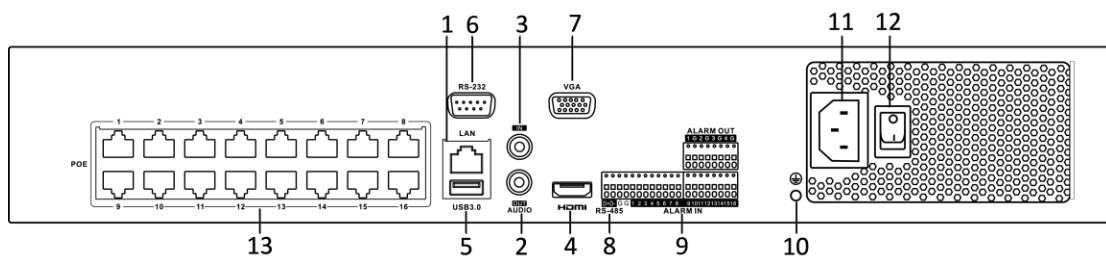

Figure 1. 9 VZ-NVR-3200-16P

Table 1. 5 Panel Description

No.	Name	Description
1	LAN Interface	1 network interface provided for VZ-NVR3200-4HD-P and VZ-NVR-3200-16P, and 2 network interfaces for VZ-NVR3200-4HD.
2	AUDIO OUT	RCA connector for audio output.
3	LINE IN	RCA connector for audio input.
4	HDMI	HDMI video output connector.
5	USB 3.0 interface	Universal Serial Bus (USB) ports for additional devices such as USB mouse and USB Hard Disk Drive (HDD).
6	RS-232 Interface	Connector for RS-232 devices.
7	VGA	DB9 connector for VGA output. Display local video output and
8	RS-485 Interface	Half-duplex connector for RS-485 devices.
9	ALARM IN	Connector for alarm input.
	ALARM OUT	Connector for alarm output.
10	GROUND	Ground (needs to be connected when NVR starts up).
11	AC 100V ~ 240V	100V to 240VAC power supply.
12	Power Switch	Switch for turning on/off the device.
13	Network Interfaces with PoE function (supported by VZ-NVR3200-4HD-P and VZ-NVR-3200-16P)	Network interfaces for the cameras and to provide power over Ethernet.

## 1.2.2 VZ-NVR-81080-P

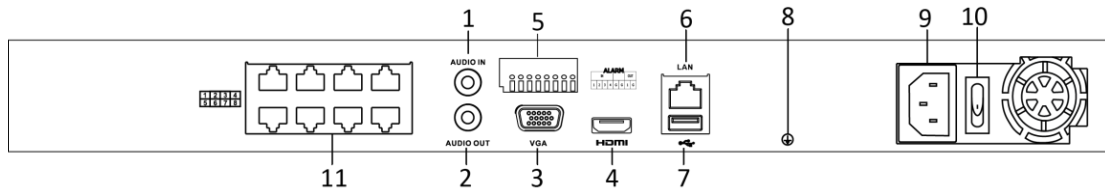

Figure 1. 11 VZ-NVR-81080-P

Table 1. 6 Panel Description

No.	Name	Description
1	Audio In	RCA connector for audio input.
2	Audio Out	RCA connector for audio output.
3	VGA Interface	DB9 connector for VGA output. Display local video output and menu.
4	HDMI Interface	HDMI video output connector.

<b>5</b>	<b>ALARM IN</b>	Connector for alarm input.
	<b>ALARM OUT</b>	Connector for alarm output.
<b>6</b>	<b>LAN Network</b>	1 10/100/1000 Mbps self-adaptive Ethernet interface
<b>7</b>	<b>USB Interface</b>	Universal Serial Bus (USB 3.0) ports for additional devices such as USB mouse and USB Hard Disk Drive (HDD).
<b>8</b>	<b>Ground</b>	Ground (needs to be connected when NVR starts up).
<b>9</b>	<b>Power Supply</b>	12 VDC power supply for VZ-NVR3200-4HD, and 100 to 240 VAC for VZ-NVR3200-4HD-P and VZ-NVR-3200-16P.
<b>10</b>	<b>Power Switch</b>	Switch for turning on/off the device.
<b>11</b>	<b>Network Interfaces with PoE function</b>	Not supported for this model

# Chapter 2 Installation and Connections

## 2.1 NVR Installation

During installation of the NVR:

1. Use brackets for rack mounting.
2. Ensure ample room for audio and video cables.
3. When routing cables, ensure that the bend radius of the cables are no less than five times than its diameter.
4. Connect the alarm cable.
5. Allow at least 2cm (≈0.75-inch) of space between racks mounted devices.
6. Ensure the NVR is grounded.
7. Environmental temperature should be within the range of -10 to +55° C, +14 to +131° F.
8. Environmental humidity should be within the range of 10% to 90%.

## 2.2 Hard Disk Installation

### ***Before you start:***

Disconnect the power from the NVR before installing a hard disk drive (HDD). A factory recommended HDD should be used for this installation.

**Tools Required:** Screwdriver.

### ***Purpose:***

The following section introduces the HDD installation. Take the example of VZ-NVR-81080-P to describe installation steps.

### ***Steps:***

1. Remove the cover from the NVR by unfastening the screws on the rear and side panel.



Figure 2. 6 Remove Cover

---

2. Connect one end of the data cable to the motherboard of NVR and the other end to the HDD.

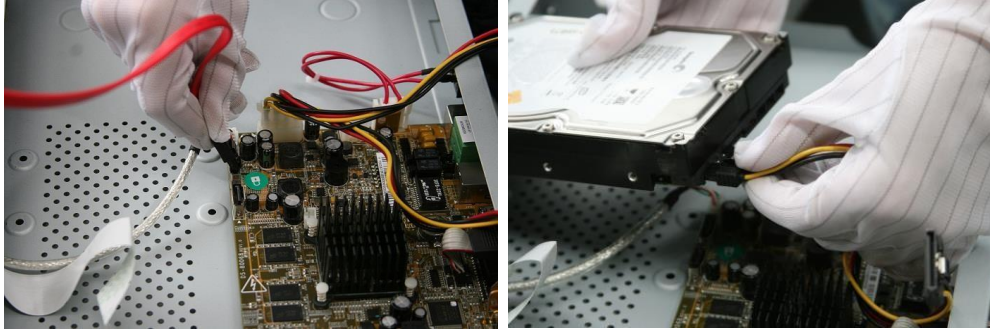

Figure 2. 7 Connect Data Cable

---

3. Connect the power cable to the HDD.



Figure 2. 8 Connect Power Cable

---

4. Place the HDD on the bottom of the device and then fasten the screws on the bottom to fix the HDD.



Figure 2. 9 Fix Hard Disk

---

## 2.3 Connections

### 2.3.1 Alarm Input Wiring

The alarm input is an open/closed relay. To connect the alarm input to the device, use the following diagram.



If the alarm input is not an open/close relay, please connect an external relay between the alarm input and the device.

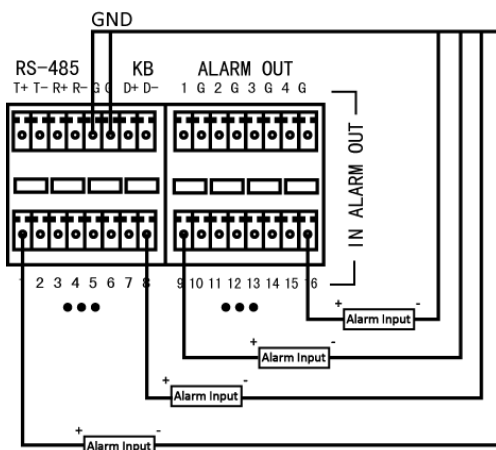

Figure 2.10 Alarm Input Wiring

### 2.3.2 Alarm Output Wiring

To connect to an alarm output (AC or DC load), use the following diagram:

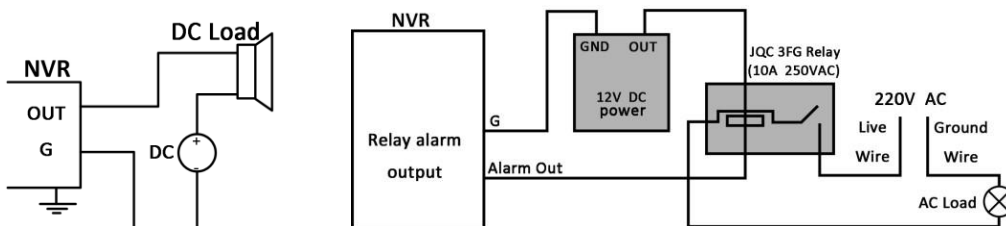

Figure 2.11 Alarm Output Wiring

For DC load, the jumpers can be used within the limit of 12V/1A safely.

To connect an AC load, jumpers should be left open (you must remove the jumper on the motherboard in the NVR). Use an external relay for safety (as shown in the figure above).

There are 4 jumpers (JP6, JP9, JP10, and JP11) on the motherboard, each corresponding with one alarm output. By default, jumpers are connected. To connect an AC load, jumpers should be removed.

**Example:**

If you connect an AC load to the alarm output 3 of the NVR, then you must remove the JP 3 jumper.

### 2.3.3 Using Alarm Connectors

To connect alarm devices to the NVR:

1. Disconnect *pluggable block* from the ALARM IN /ALARM OUT terminal block.
2. Unfasten stop screws from the *pluggable block*, insert signal cables into slots and fasten stop screws. Ensure signal cables are tight.
3. Connect *pluggable block* back into terminal block.

## 2.3.4 Controller Connection

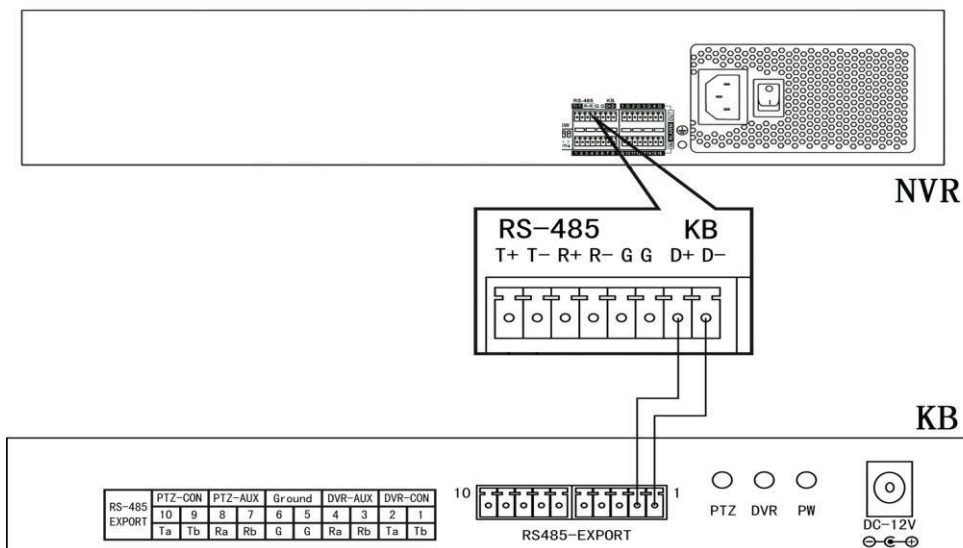

Figure 2. 12 Controller Connection

To connect a controller to the NVR:

1. Disconnect *pluggable block* from the KB terminal block.
2. Unfasten stop screws from the KB D+, D- *pluggable block*, insert signal cables into slots and fasten stop screws. Ensure signal cables are in tight.
3. Connect Ta on controller to D+ on terminal block and Tb on controller to D- on terminal block. Fasten stop screws.
4. Connect *pluggable block* back into terminal block.



Make sure both the controller and NVR are grounded.

## 2.4 HDD Storage Calculation Chart

The following chart shows an estimation of storage space used based on recording at one channel for an hour at a fixed bit rate.

Bit Rate	Storage Used
96K	42M
128K	56M
160K	70M
192K	84M
224K	98M
256K	112M
320K	140M
384K	168M
448K	196M
512K	225M
640K	281M
768K	337M
896K	393M
1024K	450M
1280K	562M
1536K	675M
1792K	787M
2048K	900M
4096K	1.8G
8192K	3.6G
16384K	7.2G



Please note that supplied values for storage space used is just for reference. The storage values in the chart are estimated by formulas and may have some deviation from actual value.

# Chapter 3 Menu Operation

## 3.1 Menu Structure

Refer to the following figure for the menu structure:

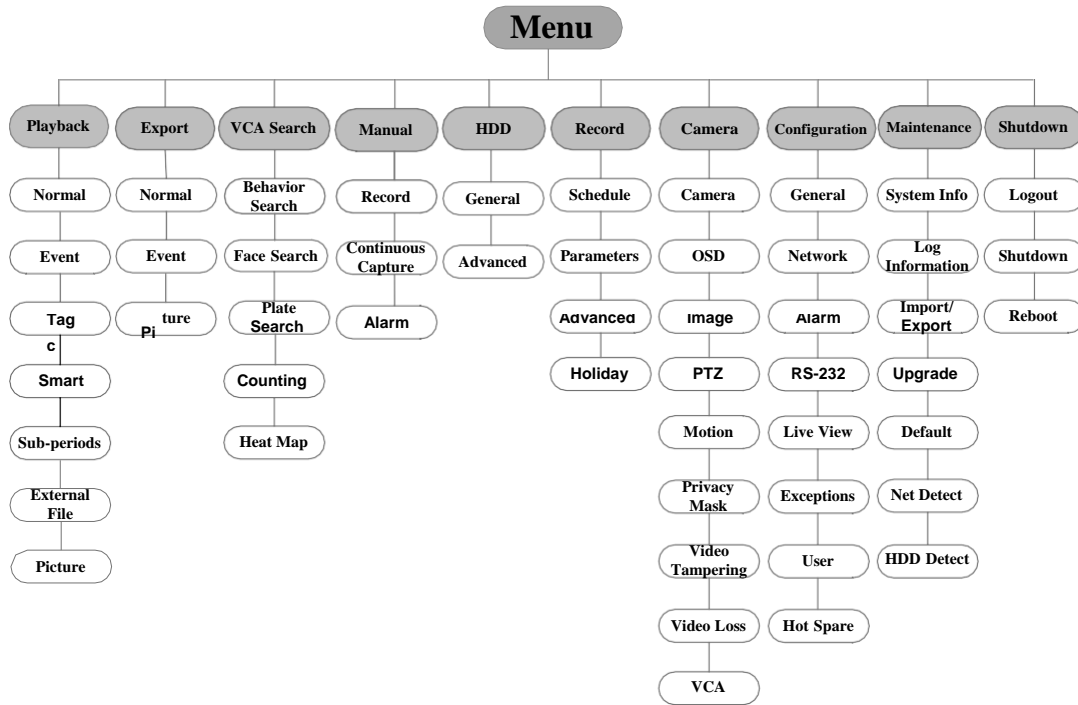

Figure 3. 1 Menu Structure



The menu structure may vary according to different models.

## 3.2 Startup and Shutdown

Proper startup and shutdown procedures are crucial to expanding the life of the NVR. To start your NVR:

1. Check the power supply is plugged into an electrical outlet. It is HIGHLY recommended that an Uninterruptible Power Supply (UPS) be used in conjunction with the device. The Power button on the front panel should be red, indicating the device is receiving the power.
2. Press the POWER button on the front panel. The Power LED should turn blue. The unit will begin to start. After the device starts up, the wizard will guide you through the initial settings, including modifying password, date and time settings, network settings, HDD initializing, and recording.

To shut down the NVR:

1. Enter the Shutdown menu.

Menu > Shutdown



Figure 3. 2 Shutdown

2. Select the **Shutdown** button.
3. Click the **Yes** button.

## 3.3 Activating Your Device

### **Purpose:**

For the first-time access, you need to activate the device by setting an admin password. No operation is allowed before activation. You can also activate the device via Web Browser, SADP or client software.

### **Steps:**

1. Input the same password in the text field of **Create New Password** and **Confirm New Password**.

Figure 3. 3 Set Admin Password



**STRONG PASSWORD RECOMMENDED**—We highly recommend you create a strong password of your own choosing (Using a minimum of 8 characters, including at least three of the following categories: upper case letters, lower case letters, numbers, and special characters.) in order to increase the security of your product. And we recommend you reset your password regularly, especially in the high security system, resetting the password monthly or weekly can better protect your product.

2. Click **OK** to save the password and activate the device.



For the old version device, if you update it to the new version, a dialog box reminding you to use a strong password will pop up once the device starts up. You can click **YES** and follow the wizard to set a strong password.

## 3.4 Using the Unlock Pattern for Login

For the Admin user, you can configure the unlock pattern for device login.

After the device is activated, you can enter the following interface to configure the device unlock pattern.

**Steps:**

1. Use the mouse to draw a pattern among the 9 dots on the screen. Release the mouse when the pattern is done.

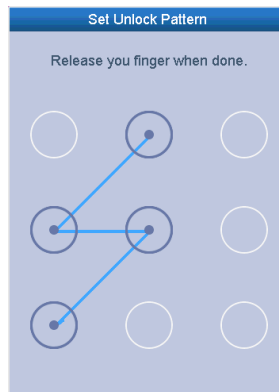

Figure 3. 4 Draw the Pattern



- Connect at least 4 dots to draw the pattern.
  - Each dot can be connected for once only.
2. Draw the same pattern again to confirm it. When the two patterns match, the pattern is configured successfully.
  3. You can use the configured unlock pattern for future login.

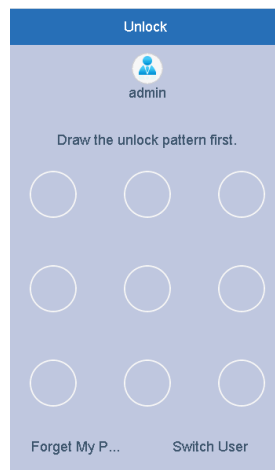

Figure 3. 5 Draw the Unlock Pattern

## 3.5 Login and Logout

### 3.5.1 User Login

**Purpose:**

If NVR has logged out, you must login the device before operating the menu and other functions.

**Steps:**

1. Select the **User Name** in the dropdown list.

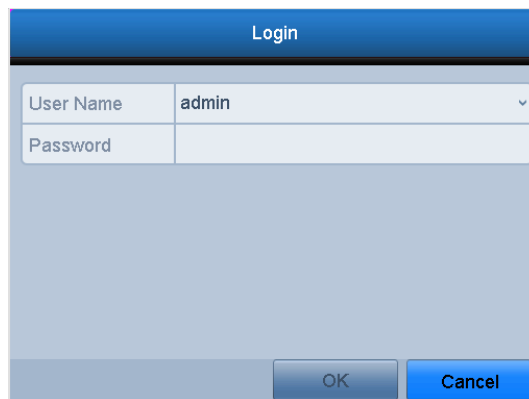

Figure 3. 6 Login

2. Input **Password**.
3. Click **OK** to log in.



In the Login dialog box, if you enter the wrong password 7 times, the current user account will be locked for 60 seconds.

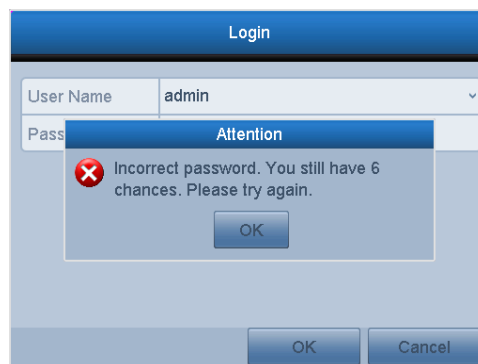

Figure 3. 7 User Account Protection for the Admin

### 3.5.2 User Logout

**Purpose:**

After logging out, the monitor turns to the live view mode and if you want to perform any operations, you need to enter user name and password log in again.

**Steps:**

1. Enter the Shutdown menu.

Menu > Shutdown



Figure 3. 8 Logout

2. Click **Logout**.



After you have logged out the system, menu operation on the screen is invalid. It is required to input a user name and password to unlock the system.

## 3.6 Using the Setup Wizard

The Setup Wizard can walk you through some important settings of the device. By default, the Setup Wizard starts once the device has loaded.

Check the checkbox to enable Setup Wizard when device starts. Click **Next** to continue the setup wizard. Follow the guide of the Setup Wizard to configure the system resolution, system date/time, network settings, HDD management, record settings, etc.



Figure 3. 9 Wizard

## 3.7 Network Settings

**Purpose:**

Network settings must be properly configured before you operate NVR over network.

**Steps:**

1. Enter the Network Settings interface.

Menu > Configuration > Network

NIC Type	10M/100M/1000M Self-adaptive		
Enable DHCP	<input checked="" type="checkbox"/>		
IPv4 Address	10 .16 .2 .109	IPv6 Address	fe80::269:6cff:fe2a:fb88/64
IPv4 Subnet	255 .255 .255 .0	IPv6 Address	
IPv4 Default	10 .16 .2 .254	IPv6 Default	
MAC Address	00:69:6c:2a:fb:88		
MTU(Bytes)	1500		
Preferred DNS Server	10.1.7.88		
Alternate DNS Server	10.1.7.77		

Figure 3. 10 Network Settings



- Two self-adaptive 10M/100M/1000M network interfaces for VZ-NVR3200-4HD, and the multi-address and network fault tolerance working modes are configurable.
  - One self-adaptive 10M/100M/1000M network interface for VZ-NVR-3200-16P.
2. Select the **General** tab.
  3. In the **General Settings** interface, you can configure the following settings: NIC Type, IPv4 Address, IPv4 Gateway, MTU and DNS Server.  
If the DHCP server is available, you can check the checkbox of **DHCP** to automatically obtain an IP address and other network settings from that server.
  4. After having configured the general settings, click the **Apply** button to save the settings.

## 3.8 Adding IP Cameras

### **Purpose:**

Before you can get live video or record the video files, you should add the network cameras to the connection list of the device.

### **Before you start:**

Ensure the network connection is valid and correct, and the IP camera to add has already been activated. Please refer to the *User Manual* for activating the inactive IP camera.

You can select one of the following three options to add the IP camera.

- **OPTION 1:**

### **Steps:**

1. Click to select an idle window in the live view mode.
2. Click the  icon in the center of the window to pop up the Add IP Camera interface.

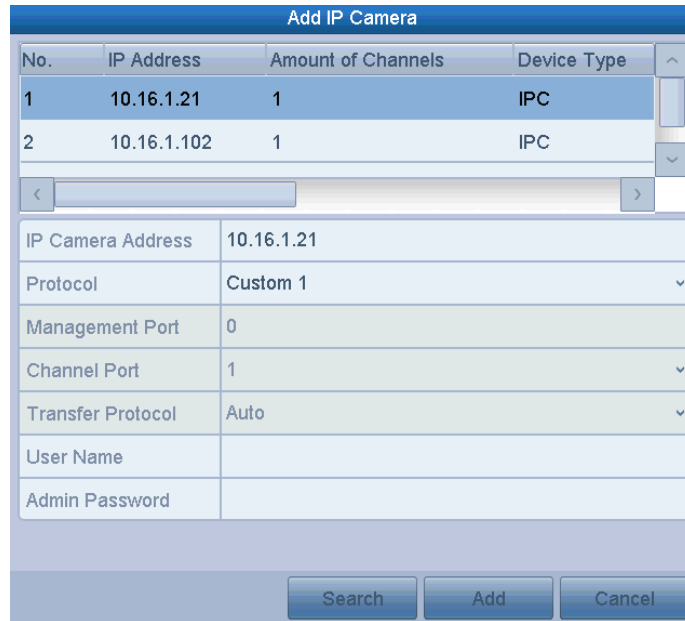

Figure 3. 11 Add IP Camera

3. Select the detected IP camera and click the **Add** button to add it directly, and you can click the **Search** button to refresh the online IP camera manually.  
Or you can choose to custom add the IP camera by editing the parameters in the corresponding text field and then click the **Add** button to add it.

## 3.9 Live View

Icons are provided on screen in Live View mode to indicate camera status. These icons include:

### Live View Icons

In the live view mode, there are icons at the upper-right corner of the screen for each channel, showing the status of the record and alarm in the channel for quick reference.



Alarm (video loss, tampering, motion detection, VCA or sensor alarm)



Record (manual record, continuous record, motion detection, VCA or alarm triggered record)

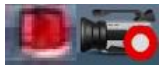

Alarm and Record



Event/Exception (event and exception information, appears at the lower-left corner of the screen.)

## 3.10 Recording Settings

### **Before you start:**

Make sure that the disk has already been installed. If not, please install a disk and initialize it. You may refer to the user manual for detailed information.

### **Purpose:**

Two kinds of record types are introduced in the following section, including Instant Record and All-day Record. And for other record types, you may refer to the user manual for detailed information.



After rebooting all the manual records enabled are canceled.

### **Steps:**



1. On the live view window, right-click the window and click the  icon (**Continuous Record**) or  icon (**Motion Detection Record**) on your demand.



Figure 3. 14 Start Recording from Right-click Menu

2. Click the **Yes** button in the pop-up Attention message box to confirm the settings. All the channels will start to record in the selected mode.

## 3.11 Playback

The recorded video files on the hard disk can be played back in the following modes: instant playback, all-day playback for the specified channel, and playback by normal/event/smart/tag/sub-periods/external file search.

### **Steps:**

1. Enter playback interface.  
Click menu>playback or from the right-click menu.
2. Check the checkbox of channel(s) in the channel list and then double-click to select a date on the calendar.
3. You can use the toolbar in the bottom part of Playback interface to control playing progress.

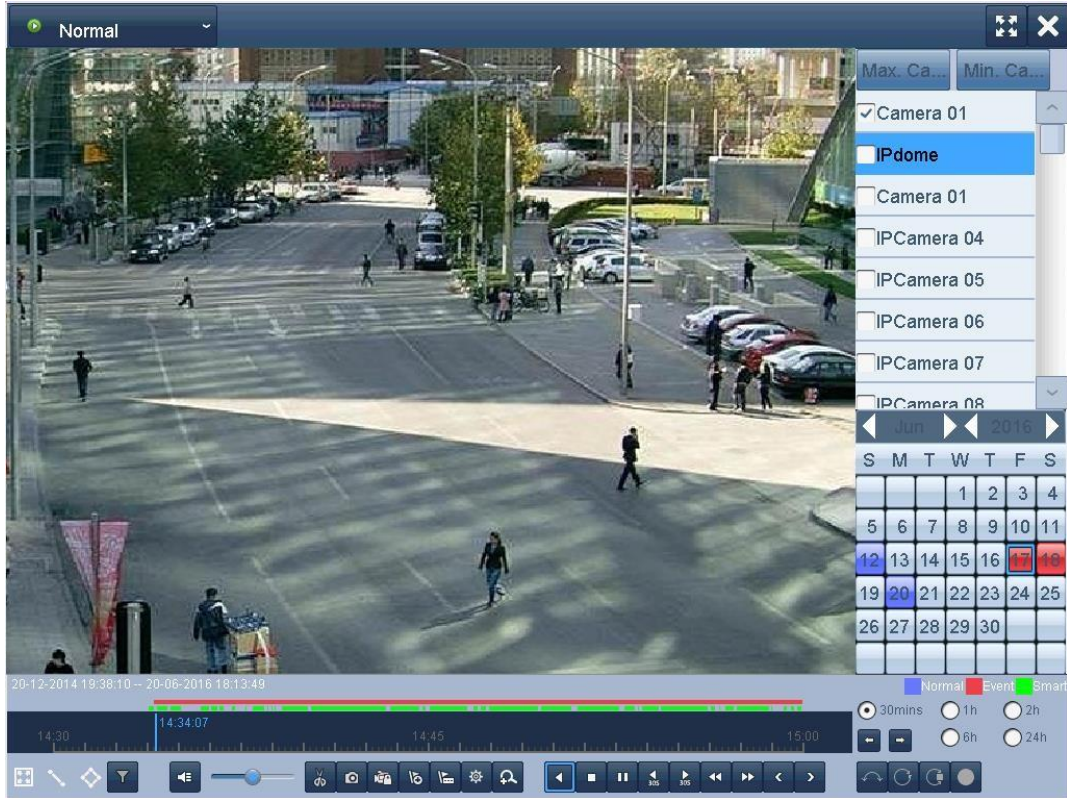

Figure 3. 15 Playback Interface

Select the channel(s) to or execute simultaneous playback of multiple channels.

## Chapter 4 Accessing by Web Browser



You shall acknowledge that the use of the product with Internet access might be under network security risks. For avoidance of any network attacks and information leakage, please strengthen your own protection. If the product does not work properly, please contact with your dealer or the nearest service center.

### **Purpose:**

You can get access to the device via web browser. You may use one of the following listed web browsers: Internet Explorer 6.0, Internet Explorer 7.0, Internet Explorer 8.0, Internet Explorer 9.0, Internet Explorer 10.0, Apple Safari, Mozilla Firefox, and Google Chrome. The supported resolutions include 1024\*768 and above.

### **Steps:**

1. Open web browser, input the IP address of the device and then press Enter.
2. Login to the device.
  - If the device has not been activated, you need to activate the device first before login.

Activation

User Name admin

Password  ✘

Valid password range [8-16]. You can use a combination of numbers, lowercase, uppercase and special character for your password with at least two kinds of them contained.

Confirm

OK

Figure 4. 1 Set Admin Password

- 1) Set the password for the admin user account.
- 2) Click **OK** to login to the device.



**STRONG PASSWORD RECOMMENDED**—We highly recommend you create a strong password of your own choosing (Using a minimum of 8 characters, including at least three of the following categories: upper case letters, lower case letters, numbers, and special characters.) in order to increase the security of your product. And we recommend you reset your password regularly, especially in the high security system, resetting the password monthly or weekly can better protect your product.

- If the device is already activated, enter the user name and password in the login interface, and click the **Login** button.



Figure 4. 2 Login

- 
3. Install the plug-in before viewing the live video and managing the camera. Please follow the installation prompts to install the plug-in.



You may have to close the web browser to finish the installation of the plug-in.

After login, you can perform the operation and configuration of the device, including the live view, playback, log search, configuration, etc.