

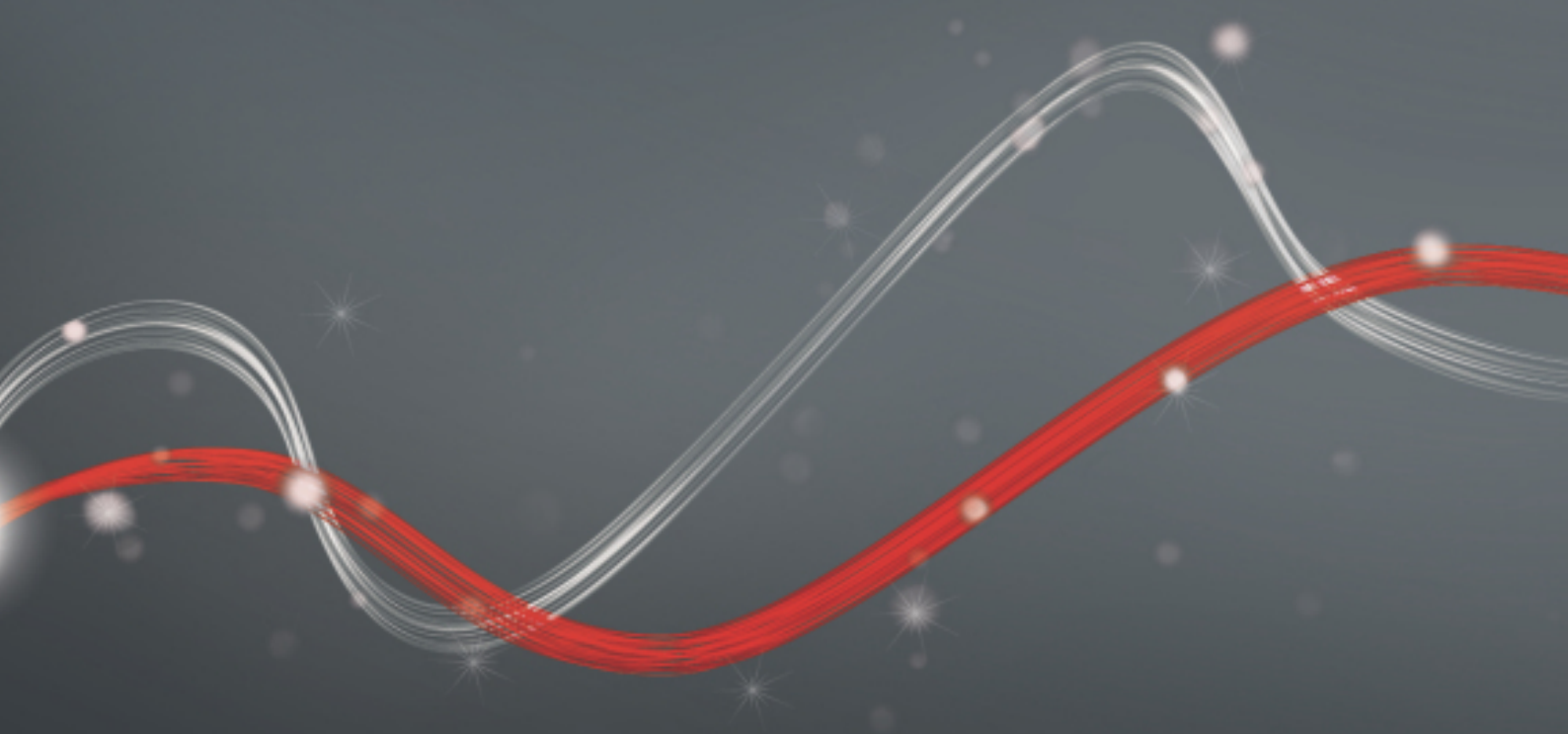

Be ahead



MICHELANGELO BT A



Product

PLUS

TECHNICAL FEATURES

ACCESSORIES

DISCOVER U-LINK

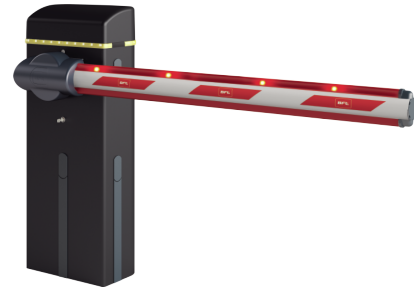

- ee link
- 24 V
- er ready
- U-Link



Range of barriers for very intensive use, for clear openings of up to 8 metres. The wide range of accessories, incorporated flashing light and the arrangement for photocells make them ideal in any context

MICHELANGELO BT A

Code	Name	Description	
P940076 00002	MICHELANGELO BT A 60 U	Barrier with 24 V power supply for useful passage up to 6 m and opening time 6 sec. Impact reaction via encoder. Control unit with ULink slot, display and receiver in head. RAL 7015 grey colour	
P940076 00102	MICHELANGELO BT A 60 U RAL	Barrier with 24 V power supply for useful passage up to 6 m and opening time 6 sec. Impact reaction via encoder. Control unit with ULink slot, display and receiver in head. RAL colour on request.	
P940076 00001	MICHELANGELO BT A 60 U 120	Barrier with 24 V power supply for useful passage up to 6 m and opening time 6 sec. Impact reaction via . Control unit with ULink slot, display and receiver in head. RAL 7015 grey colour	
P940076 00101	MICHELANGELO BT A 60 U 120 RAL	Barrier with 24 V power supply for useful passage up to 6 m and opening time 6 sec. Impact reaction via . Control unit with ULink slot, display and receiver in head. RAL colour on request	
P940077 00002	MICHELANGELO BT A 80 U	Barrier with 24 V power supply for useful passage up to 8 m and opening time 8 sec. Impact reaction via . Control unit with ULink slot, display and receiver in head. RAL 7015 grey colour	
P940077 00102	MICHELANGELO BT A 80 U RAL	Barrier with 24 V power supply for useful passage up to 8 m and opening time 8 sec. Impact reaction via . Control unit with ULink slot, display and receiver in head. RAL colour on request	

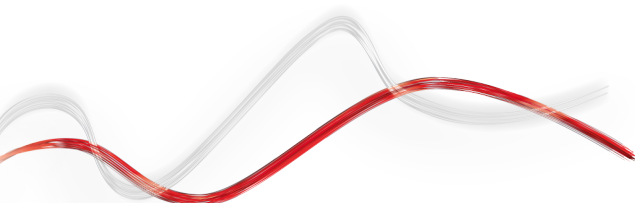

• Product

• PLUS

• TECHNICAL FEATURES

• ACCESSORIES

• DISCOVER U-LINK

MICHELANGELO BT A



Code	Name	Description
P940077 00001	MICHELANGELO BT A 80 U 120	Barrier with 24 V power supply for useful passage up to 8 m and opening time 8 sec. Impact reaction via . Control unit with ULink slot, display and receiver in head. RAL 7015 grey colour
P940077 00101	MICHELANGELO BT A 80 U 120 RAL	Barrier with 24 V power supply for useful passage up to 8 m and opening time 8 sec. Impact reaction via . Control unit with ULink slot, display and receiver in head. RAL colour on request

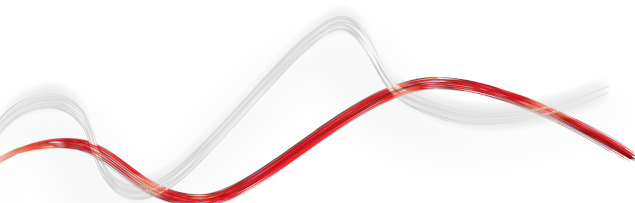

· Product

· **PLUS**

· TECHNICAL FEATURES

· ACCESSORIES

· **DISCOVER U-LINK**

PLUS



New control board Merak BM with U-Link connectivity slot, programming display and two-channel radio receiver incorporated. Mounted in the upper part of the barrier for an easier and convenient access.



IP54 protection level and new design.

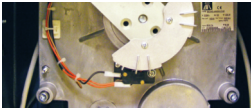

Limit switch system with electronic adjustment that speeds up installation and ensures maximum precision in movement.



Backup battery power supply system, installable on-board unit.

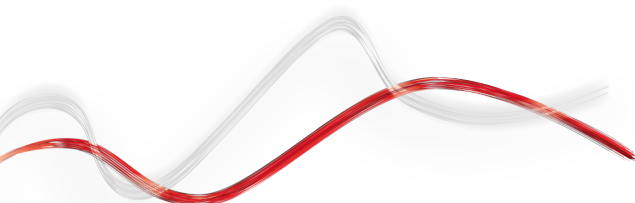

• Product

• PLUS

• TECHNICAL FEATURES

• ACCESSORIES

• DISCOVER U-LINK

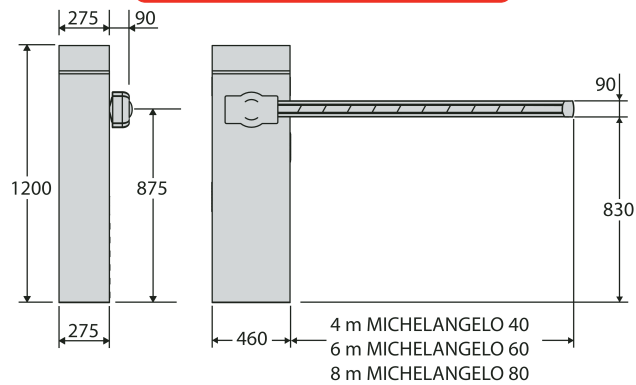

	MICHELANGELO BT A 60 U	MICHELANGELO BT A 60 U RAL	MICHELANGELO BT A 60 U 120	MICHELANGELO BT A 60 U 120 RAL	MICHELANGELO BT A 80 U	MICHELANGELO BT A 80 U RAL	MICHELANGELO BT A 80 U 120	MICHELANGELO BT A 80 U 120 RAL
Useful passage	6 m				8 m			
Opening or closing time	6 sec				8 sec			
Control unit	MERAK BM							
Motor power supply	24 V							
Type of limit switch	electronic							
Slowdown	adjustable							
Locking	mechanical							
Release	key							
Frequency of use	intensive							
Environmental conditions	from -20 (-40 with thermo) °C to 50 °C							
Protection rating	IP54							

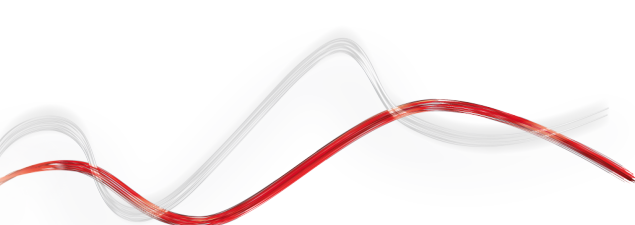









· Product

· PLUS

· TECHNICAL FEATURES

· **ACCESSORIES**

· DISCOVER U-LINK

	Code	Name	Description
	D730964	BM	adjustable base plate for mod. MICHELANGELO - BM
	N728022	AQ6	Complete 6 m rectangular boom for MICHELANGELO
	N728026	AT 704	Round boom \varnothing 70 mm, length 4.3 m. for clear spaces up to 4 m ATT 704
	N728030	AT 706	Round boom diam. 70 mm length 6.35 m for MICHELANGELO. for openings up to 6 m
	N728028	AT 502	Second part of telescopic round boom for MICHELANGELO, diam. 50 mm, length 2.6 m.
	N728027	AT 504	Second part of telescopic round boom for MICHELANGELO, diam. 50 mm, length 4.6 m.
	N999606	OMEGA AQ 6	Accessories pack for AQ 6 boom
	N999607	OMEGA AT 70	Accessories pack for AT 704/706
	P120072	KIT ML MCL40	Michelangelo 60 to Michelangelo 40 conversion kit
	P120028 00001	PCA N3	Top and bottom rubber cover profile for booms of 3 m max.
	P120028 00002	PCA N4	Top and bottom rubber cover profile for booms of 4 m max.
	P120028 00003	PCA N5	Top and bottom rubber cover profile for booms of 5 m max.
	P120028 00004	PCA N6	Top and bottom rubber cover profile for booms of 6 m max.
	P120028 00005	PCA N8	Top and bottom rubber cover profile for booms of 8 m max.
	P120006	MCL LAMPO KIT	Integrated flashing light. The MCL CARD KIT is needed for operation
	P120009	SCHEDA MCL KIT	Control board for KIT MCL LIGHT and KIT MCL LAMPO
	P120005 00001	MCL LIGHT KIT	Set of lights (6) for boom. To be used with (MCL) PCA 6, PCA 8. The MCL CARD KIT is necessary for operation
	D573003	SB	Aluminium skirt for road barrier booms. Price per linear metre (Calculate length of useful passage minus 40cm)
	P120023 00100	FAF 2 RAL	Fixed rest fork for booms with customised RAL colour. For bolting to ground.
	P120023	FAF 2	Rest fork for booms. For bolting to ground.

· Product

· PLUS

· TECHNICAL FEATURES

· **ACCESSORIES**

· DISCOVER U-LINK

	Code	Name	Description
	P120025 00100	FAF 2R RAL	Fixed rest fork for booms with customised RAL colour. For bolting to ground.
	P120026	ZFAF2	Additional anchor plates for cementing FAF2 forks to ground.
	D940007	GAM	Mobile rest leg for BGV barrier boom (not usable on BGV 30)
	D940008	GA AQ AT	Movable support leg for AQ or AT booms (on MOOVI, MICHELANGELO and GIOTTO barriers)
	D940009	GAMA AQ AT	Dampened movable support leg for AQ or AT booms (on MOOVI, MICHELANGELO and GIOTTO barriers)
	P120018	THERMO	Thermostatically controlled heating element for use of GIOTTO BT A, MOOVI, MICHELANGELO BT A barriers to ambient temperatures of -40°C
	N190104	BIR C	Rubber safety edge (H 30 mm), price per m
	P111409	S RFLP	Reflector and support for wall mounting and mounting on CC post for CELLULA RFL
	P903015 00001	KIT BARR RFL	RFL mount. Fits onto the MICHELANGELO operator enclosure in line with the boom.
	D111904	MITTO B RCB02 R1	Transmitter with 2 channels. Range 50/100 m. Power supply 12 V with 1 battery type 23 A
	D831081	CMS	Sign
	P125038	MCL BT A BAT KIT	Set of backup batteries for MICHELANGELO barriers
	P111537	ERIS A30	<div style="display: flex; align-items: center;"> Pair of wireless photocells with possibility of management of an active infrared or resistive safety edge adding STR and BIR C or BAR C profiles. Possibility of adjusting the beam 180 ° horizontally and vertically 20 °. Range 30 m. Power supply 24 V ac/dc. </div>

· Product

· PLUS

· TECHNICAL FEATURES

· **ACCESSORIES**

· DISCOVER U-LINK

	Code	Name		Description
	P111526	DESME A15		Pair of self-aligning photocells. Range 30 m. Power supply 24 V ac/dc. Pair of self-aligning photocells. Range 30 m. Power supply 24 V ac/dc.
	P111527	DESME A15 O		Pair of photocells adjustable 40 ° horizontally and 10 ° vertically. IR signal synchronised to prevent any risk of blinding. Range 30 m. Power supply 24 V ac/dc.
	P111528	THEA A15 O.PF		Pair of adjustable photocells with integrated flashing light. Possibility of directing the beam 40 ° horizontally and 10 ° vertically. IR signal synchronised to prevent any risk of blinding. Range 30 m. Power supply 24 V ac/dc. For external application.
	P903018	PHP		Pair of aluminium posts for THEA/DESME series photocells Height 522 mm
	P903019	PHP2		Pair of double aluminium posts for THEA/DESME series photocells. Height 1038 mm
	P903023	PHP BA1		Support for mounting THEA/DESME photocells on Giotto, Moovi and Michelangelo enclosures
	P903025	PHP ADA		Pair of adapters for the installation of AKTA photocells on PHP posts
	P111401 00001	VENTIMIGLIA NS		Infrared device for BIR C or BAR C safety edges (conforms to EN 12978 Standard)
	P121023	Q.BO KEY WM AV		Vandalproof key selector with double contact, for outdoor use. Metal structure. Vandalproof key selector with metal structure.
	P121024	Q.BO TOUCH		Wireless digital touchpad with 433MHz rolling code operation. Manages up to 10 channels and 100 codes.
	P111001 00003	RME 2		230Vac dual channel metal object detector Supplied with RME 2 installation base
	P111274	RME 1 BT		24Vac single channel metal object detector with installation base
	D110926 00001	SPIRA 2X1		Magnetic loop 2 x 1 m
	N999608	ACTR		Pack of 12 additional reflective labels (1 pack already included with each boom)

Product

PLUS

TECHNICAL FEATURES

ACCESSORIES

DISCOVER U-LINK

	Code	Name	Description
	N999471	ECOSOL PANEL	Solar panel with maximum power of 35 Wp for charging the ECOSOL system. Max 3 panels per system
	D113732	ECOSOL DOUBLE	Expansion board with batteries Included
	D113731	ECOSOL BOX	Control and management unit for solar power supply of systems with supply voltage of 24 V. Batteries included.
	N999477	ECOSOL CHARGER	100-230V - 24V battery charger for rapid charging from mains for ECOSOL BOX and ECOSOL DOUBLE - ECOSOL CHARGER
	N999476	ECOSOL CABLE	20 m extension for ECOSOL CHARGER - ECOSOL CABLE
	N999473	ECOSOL POST BR	Set of stainless steel screws and brackets for installing the ECOSOL PANEL on a post of diameter 48-100mm ECOSOL POST BR
	N999475	ECOSOL SECURITY	Anti-tamper stainless steel screw fastener kit for ECOSOL PANEL and ECOSOL POST BR - ECOSOL SECURITY
	P111468	B EBA R5 485 LINK	Expansion board for connection of central units with serial controls management
	P111532	B EBA BLUE ENTRY ANDROID 8	BLUE-TOOTH expansion card for Blue Entry system. Manages up to 8 smartphones with the Android operating system
	P111533	B EBA BLUE ENTRY ANDROID 16	BLUE-TOOTH expansion card for Blue Entry system. Manages up to 16 smartphones with the Android operating system
	P111469	B EBA BLUE GATEWAY	Expansion board for BLUETOOTH connection management
	P111531	B EBA BLUE ENTRY ANDROID 4	BLUE-TOOTH expansion card for Blue Entry system. Manages up to 4 smartphones with the Android operating system
	P111535	BEBA Z-WAVE DRIVER	Expansion card for connection with Z-Wave wireless protocol
	P111466	B EBA IO DRIVER	INPUT/OUTPUT expansion board
	P111467	B EBA WIE DRIVER	Expansion card for connection of WIEGAND accessories, compatible with U-Link control units
	D113674 00001	CLONIX 2E	CLONIX 2E 433 MHZ dual channel external receiver with rolling code (to be used if there is no CLONIX receiver in the system)





· Product

· PLUS

· TECHNICAL FEATURES

· **ACCESSORIES**

· DISCOVER U-LINK

	Code	Name	Description
	D113746 00003	GSM RECEIVER	GSM receiver. Enables the operation of an automation system with a free phone call
	D113807 00002	CLONIX 2E AC U-LINK 230	 433MHz 2ch external receiver 433Mhz external receiver with 2 outputs with NO contact. Compatible with U-LINK protocol (with 3 connection slots). Power supply 230V, 2048-position memory
	D113808 00003	CLONIX UNI AC U-LINK 230V	 433MHz 3ch external receiver U-LINK 433Mhz external receiver with 3 outputs: 2 with NO contact and one NO/NC configurable. Compatible with U-LINK protocol (with 3 connection slots). Power supply 230V, 2048-position memory
	D113718 00002	CLONIX 4 RTE	External 4-channel 433 MHz rolling code receiver. Power relay outputs (16A 230v)

· Product

· PLUS

· TECHNICAL FEATURES

· ACCESSORIES

· DISCOVER U-LINK

What is U-Link?

The innovative technology that gives you new power

An exclusive Bft innovation: U-Link (Universal Link) is an exclusive Bft platform that allows the creation of technological ecosystems. In Home Automation Access, it allows communication with all the home access automation devices of any brand. So you save time and can control everything with ease, without any worries.

It is intuitive

Easy to install and use

It is scalable

Allows an unlimited number of devices to be added

It is flexible

Allows the creation of groups of interconnected products

It is practical

Works with or without a web connection

It is functional

Parameters can be controlled remotely via dedicated applications

· Product

· PLUS

· TECHNICAL FEATURES

· ACCESSORIES

· DISCOVER U-LINK

All in one scheme: discover this amazing technology

A unique platform **allowing the creation of technological ecosystems** offering a wide range of solutions for different sectors.

Thanks to the B-Eba cards and the Clonix U-Link receiver, this proprietary platform featured by Bft products adapts to any protocol and access automation product (even BFT, non-native U-Link or non-BFT products), and is used in various sectors. Each device thus becomes smart and can be interconnected with other systems, thanks to a language that becomes universal.

U-Base 2



Software to install and easily and comfortably carry out maintenance and identify any malfunction of U-link compatible operators.

U-SDK



U-SDK is the innovative application that can make Bft automation systems compatible and easily integrated with a BMS network for the supervision of buildings.



Magistro

An innovative and easy to install system for easily managing all home automation systems.



U-Control

U-Control is the application that helps the quick and easy integration of BFT automation systems in large building management systems.



Blue-Entry

Technology abreast of the times and attentive to daily needs: thanks to the use of U-link the house gate can now be opened with just your smartphone.



Clonix U-Link

Allows the connection of non-native U-Link products or non-Bft products to U-Link systems.

Bft operators, non-native U-Link products or a product belonging to other brands: can they be connected to U-Link? Yes, thanks to the Clonix receivers. Accessories that know no limits.

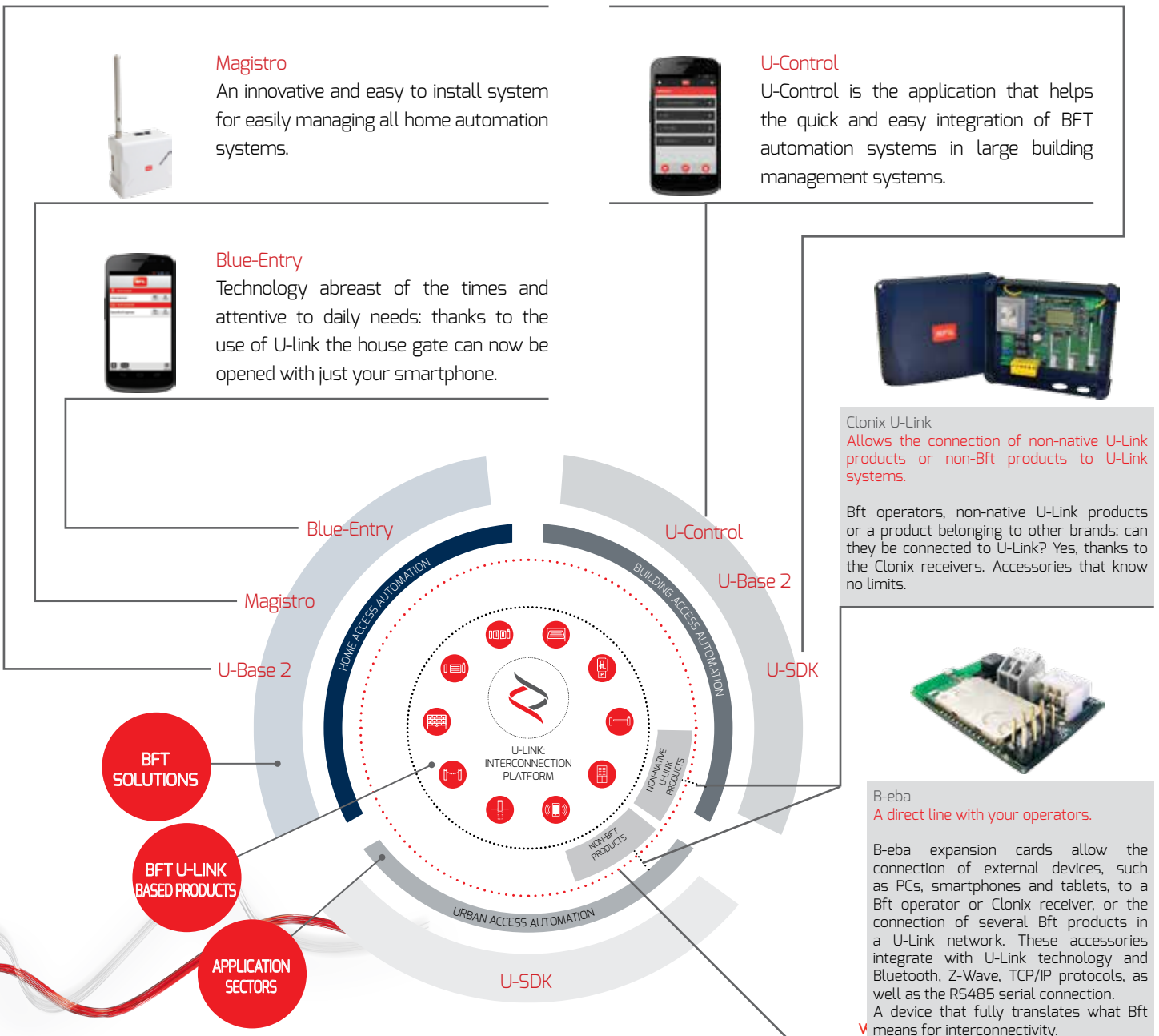

B-Eba

A direct line with your operators.

B-Eba expansion cards allow the connection of external devices, such as PCs, smartphones and tablets, to a Bft operator or Clonix receiver, or the connection of several Bft products in a U-Link network. These accessories integrate with U-Link technology and Bluetooth, Z-Wave, TCP/IP protocols, as well as the RS485 serial connection.

A device that fully translates what Bft means for interconnectivity.



INFORMATION REGARDING THE PROTECTION OF THE INDUSTRIAL AND INTELLECTUAL PROPERTY RIGHTS OF BFT. BFT S.p.A. protects its industrial property by depositing trademarks, patents, models and designs. The intellectual property of BFT S.p.A. is protected by copyright law. BFT S.p.A. also protects its know-how by taking measures to protect the technical and commercial information inherent in its company and products. All the products in this catalogue are ORIGINAL BFT MODELS and only BFT S.p.A is authorised to produce them and market them anywhere in the world. All the commercial names in this catalogue are owned by BFT S.p.A., and only BFT S.p.A. is authorised to use them in relation to the corresponding merchandise category. FALSIFIERS WILL BE PROCEEDED AGAINST IN ACCORDANCE WITH BOTH CIVIL AND CRIMINAL LAW. THESE CONDITIONS NOT ONLY GUARANTEE THE INTELLECTUAL PROPERTY RIGHTS OF BFT, BUT ALSO PROTECT CUSTOMERS BY GUARANTEEING THAT THE PRODUCTS THEY ARE PURCHASING ARE ORIGINAL BFT PRODUCTS RESULTING FROM STUDIES AND DESIGNS WITHIN THE BFT COMPANY.